



**SIEMENS**

*Ingenuity for life*

Siemens PLM Software

## Transfer path analysis

Qualifying and quantifying vibro-acoustic transfer paths

### Executive summary

By using transfer path analysis (TPA), manufacturers mathematically evaluate noise contributions from the source to the receiver. This methodical approach to vibro-acoustic design helps to identify which components and structures contribute to specific noise issues. The results are used to optimize the design by choosing desirable characteristics for these components. This methodology gives complete insights into the noise, vibration and harshness (NVH) behavior, leading to faster troubleshooting and better product refinement. Although this white paper describes TPA for automotive vehicles, this methodology can also be applied to all mechanical machines.

# Contents

<b>Abstract .....</b>	<b>3</b>
Fundamentals of TPA .....	3
Examples of when TPA is applied.....	7
<b>The TPA process .....</b>	<b>9</b>
Structure-borne loads estimation .....	9
Airborne loads estimation, acoustic source quantification.....	11
Gathering high-quality FRF data .....	12
Multi-reference TPA.....	13
Organizing the results.....	14
<b>Beyond traditional applications .....</b>	<b>15</b>
Speeding up the TPA process.....	15
Energetic power-based ASQ .....	15
Time-domain TPA .....	16
Strain-based TPA .....	18
Component-based TPA (blocked forces TPA) .....	18
Model-based transfer path analysis.....	18
<b>Providing a more systematic approach to vibro-acoustic design .....</b>	<b>20</b>
Bibliography .....	20

# Abstract

For decades, the automotive industry has focused its efforts on developing fuel-efficient and zero-emission vehicles. More recently, original equipment manufacturers (OEMs) have begun taking significant steps towards developing autonomous vehicles. Although both efforts are of the utmost importance to achieving sustainable mobility, the industry considers the driving experience the prevailing buying criterion. Accordingly, manufacturers must properly balance more traditional attributes such as durability, NVH and safety.

This paper addresses the challenges that arise in the field of NVH, as well as possible methodologies for solving issues in this area. Although NVH concerns a well-established attribute in vehicle engineering, the evolution of driveline technologies and lightweight body construction poses significant challenges to the NVH engineering community.

Next to balancing the NVH performance with fuel efficiency and autonomy, the complexity significantly increases since the overall perceived sound depends on the level and nature of the noise source(s), as well as on the paths that structural and airborne loads follow before they are perceived by the passenger. Due to this complexity, the source-transfer-receiver approach is deemed the most appropriate to investigate and understand NVH.

The concept of the source-transfer-receiver approach is rather simple. Noise and vibration issues originate from a source. This source transfers energy via one or more transfer paths that can be either structure-borne or airborne. In structure-borne paths, the energy is mechanically transferred (for example, through mounts) from the source into the structure and finds its way to the receiver as vibration energy. In case of airborne paths, energy is radiated from the source into air. As such, the transfer medium of airborne paths is the surrounding air.

Deciding whether noise should be treated as structure or airborne is not as straightforward as it seems. For instance, consider when noise first travels through a structural path, but then becomes airborne when radiated by a body panel. In this and similar instances, the decision on the type of transfer path is directly related to the engineer's definition of source and path. The latter decides which components and parts should be considered part of the source, and from which parts he or she considers the transfer path to begin (this is called "making the cut"). It is the interface between source and transfer path that determines whether the noise should be considered structural or airborne. In the example in which structure-borne noise becomes airborne, it is the transfer path directly adjacent to the source, which is structural in this case, that establishes how the NVH issue should be treated.

The most appropriate way to objectively describe both the sources as well as the transfer paths within a source-transfer-receiver model is TPA. By means of TPA, one can mathematically evaluate noise contributions from their source, along their transfer paths and all the way to the receiver. As such, TPA enables engineering departments to identify components and structures that need to be modified to resolve specific issues. Choosing more desirable characteristics for these components will ultimately optimize vehicle design.

## Fundamentals of TPA

In order to explain the fundamental principles behind TPA, it is important to understand the essential elements from the source-transfer-receiver model:

- The excitation sources: These can be structure and/or airborne, acoustical or vibration. Typical sources for a vehicle include the vibration of the engine, intake noise, tailpipe noise, road-induced vibrations, or radiated noise from vibrating panels
- The transfer paths: Structural transfer paths are represented by the physical mounts and rigid connections, by which the noise and vibration are transferred from the source to the target location. Examples of airborne transfer paths are vibrating panels, intake or exhaust nozzles

- The receiver locations: These are typically acoustical, such as the acoustic pressure perceived by the passengers in a vehicle during engine runup. It can also be vibrations in the steering wheel or seat rails, the noise perceived by the user of a household machine, or the vibration of a space station caused by an instrument in operation on the carrier platform

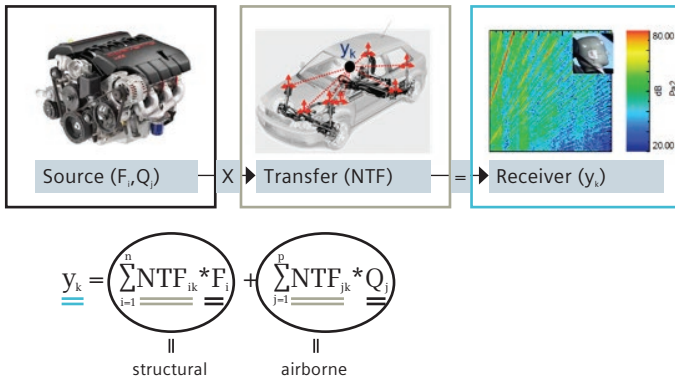

Figure 1: The source-transfer-receiver model.

The source-transfer-receiver method decomposes operational data, measured from a target or receiver location, into a sum of individual partial contributions, often referred to as partial pressures or accelerations. These partial contributions can be written as operational quantities at the path or source, multiplied with the transfer function between the path and the target.

Typically, these results are summarized in a path contribution plot that shows the contribution of each path to the target as shown on figure 2.

Each path contribution adds to the operational loads and its transfer.

$$y_k(\omega) = \sum_{i=1}^n y_{ik}(\omega) + \sum_{j=1}^p y_{jk}(\omega) \quad \text{with } y_{ik}(\omega) = FRF_{ik}(\omega) * F_i(\omega) \text{ and } y_{jk}(\omega) = FRF_{jk}(\omega) * Q_j(\omega)$$

The procedure to build a conventional TPA model consists of two steps:

1. Identify operational loads from in-operation tests (for example, runup, rundown) on the road or on a chassis dyno.
2. Estimate the frequency response functions (FRF) between the load interfaces and target locations.

The procedure is similar for both structural and acoustic load cases, but the practical implementation is governed by the nature of the signals and loads.

The measurement of the FRFs between input loads and target response(s) is probably the easiest to carry out and often takes advantage of the reciprocity principle, applying excitation at the target location (for example, by a volume velocity source) and measuring the response at the load-path interface. We'll come back to that later.

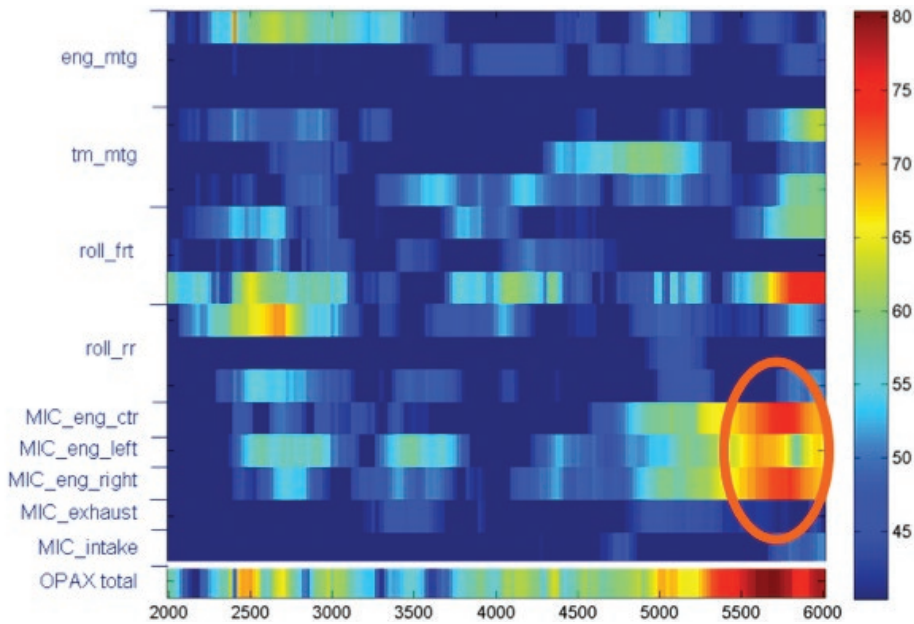

Figure 2: Path contribution plot.

*Illustrative example*

To explain this process, let's take a look at a simple generic example of an engine in a car. The engine can be seen as a source that generates vibrations and sound in the vehicle through multiple paths: Force comes through its mounts, hence structure-borne paths and acoustic volume velocity sources travel through the air or follow an airborne transfer path. With TPA, we quantify each of these loads, and multiply them with each of their transfer functions to understand the contribution of these paths to a certain target (for example, interior microphone). In this way, we can assess *which* is the dominant path and investigate *why* it is dominant. TPA decomposes each of the paths in source and transfer. This unique feature gives great physical insight into the noise generation mechanism. In the next figures the process is explained with a generic, simplified example of a car powertrain:

1. Issue under investigation: Car with booming noise issue at 3,800 rotations per minute (RPM). The color map highlights the problem from 100 to 140 hertz (Hz). When the engine revs at 3,800 RPM, an annoying noise is perceived in the car.

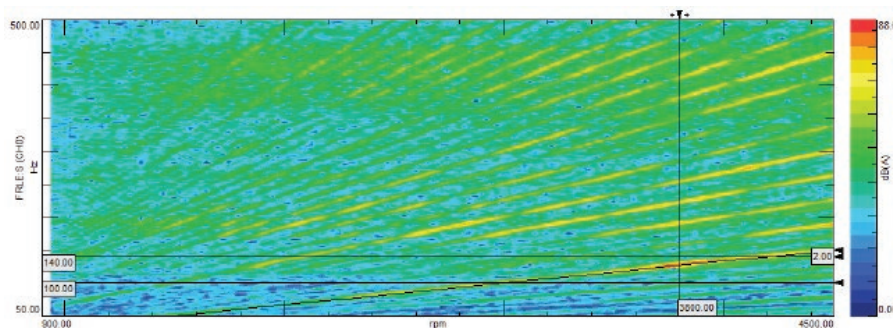
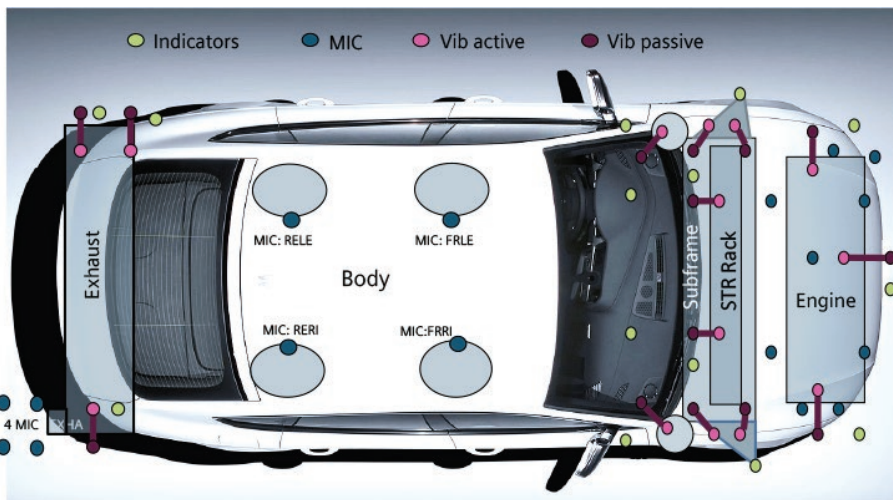

Figure 3: Top: Sensor locations. Bottom: Color map of a vehicle showing low-frequency booming noise.

2. A complete TPA is performed to gain insight into the full NVH behavior of the engine in the vehicle. It identifies the path causing the high vibration levels.

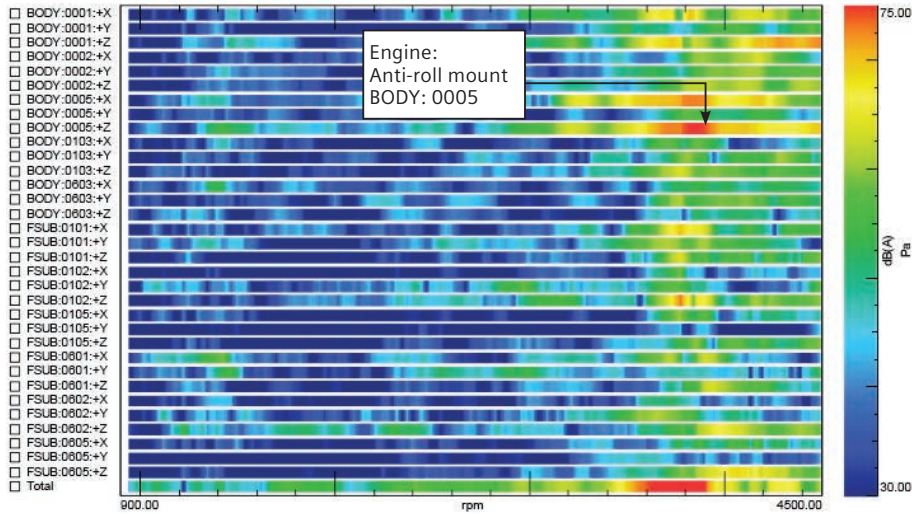

Figure 4: Example of a TPA in which all paths are quantified as a function of RPM or frequency.

3. The dominant path is investigated in detail. A first step is to look at the separation between source and transfer of this specific path.

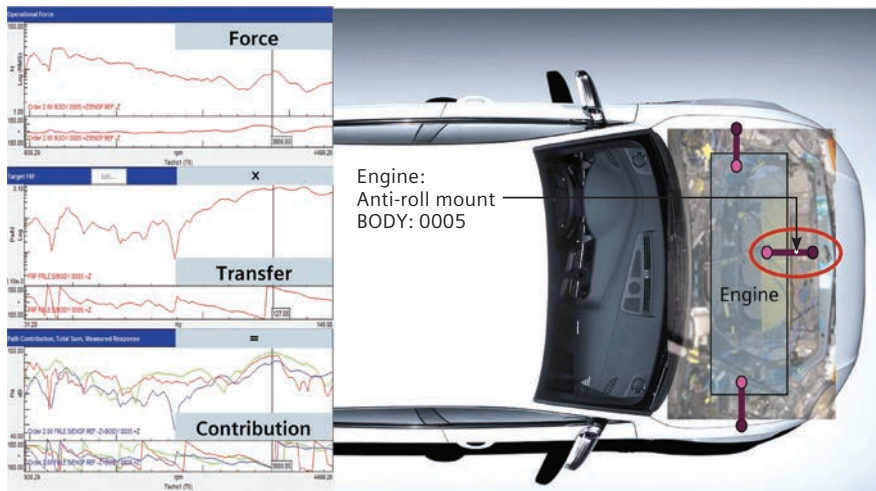

Figure 5: Anti-roll mount identified as most dominant path at 3,800 RPM.

4. The engineer can pinpoint the cause of the issue. Countermeasures can be proposed. The effect of modifications can virtually be predicted using the same model; even auralization of each of the contributions or modified total sound is possible.

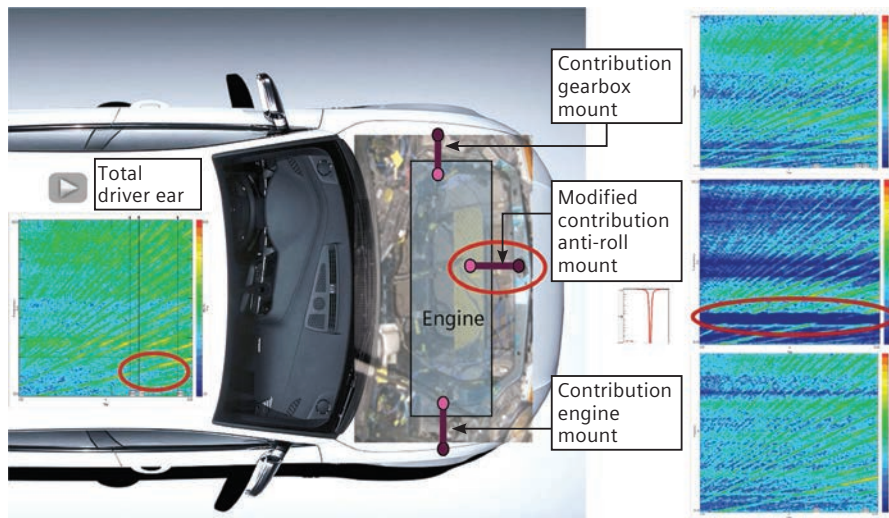

Figure 6: Exact location of the NVH issue.

This simplified example shows the value and insight provided by the TPA process so the user can understand the NVH behavior of a complex system. The methodology was developed as a result of research carried out in the 1980s and 1990s. The first TPA product was industrialized in the early 1990s using an early version (CADA-X platform) of Simcenter Testlab™ software. More than 20 years later these methods are considered the best way to keep control of NVH attributes of products in mechanical industries worldwide.

### Examples of when TPA is applied

TPA is a powerful tool that can be applied at several stages of development. This includes early in the development cycle for target setting, in detailed engineering for obtaining realistic loads and troubleshooting when a physical prototype is available. It gives complete insight into NVH behavior and leads to faster troubleshooting, better product refinement and a more methodical approach to vibro-acoustic design.

### Benchmarking and target setting

In the initial stages of a new car program, the final performance targets for the vehicle are defined. This is most commonly done by assessing previous generations of the same vehicle, as well as by establishing the performance of competitor cars/products and deriving

overall performance indicators. It is a worthwhile exercise to measure the overall behavior of the benchmark vehicles. However, performing full TPA analyses helps to define the overall targets as well as subsystem and component targets, hence providing clear goals to compare against for the detailed engineering teams.

### Vehicle development

Although TPA was originally a test-based troubleshooting tool, it has proven useful throughout all stages of development. Applying the same methodology for source or transfer models derived from either test or simulation techniques provides a lot of additional insight for engineering vibro-acoustic energy flows in a vehicle.

### Pass-by noise engineering

With new International Organization for Standardization (ISO) standards and testing regulations being implemented, pass-by noise (PBN) has renewed interest in this phenomenon amongst engineers. Masking techniques to isolate noise sources on a test track have been used for decades, but new processing techniques along with the application of TPA are enhancing the possibilities for PBN testing. Ultimately, TPA allows you to quantify the different noise contributors more accurately, such as exhaust and engine and tires, and enables more targeted modifications to be implemented.

### Troubleshooting

As previously mentioned, TPA was traditionally applied in the domain of troubleshooting NVH problems. The contribution of TPA in this regard remains vital. TPA provides a way to single out the transfer paths that are negatively impacting a vehicle's NVH behavior, and thereby allows engineers to focus on areas that are related to the problem. In this sense, it is a huge step up from traditional ad hoc untargeted trial-and-error methods, which rarely lead to an optimal solution.

### Other solutions

TPA can be applied to solve vibro-acoustics issues in a variety of large and small mechanical machinery, including: ships, wind turbines, motorcycles, trains, compressors, large engines and even full aircraft. TPA methods have been applied to reduce sound power levels in printers and copiers as well as household appliances, such as refrigerators, washing machines and dishwashers.

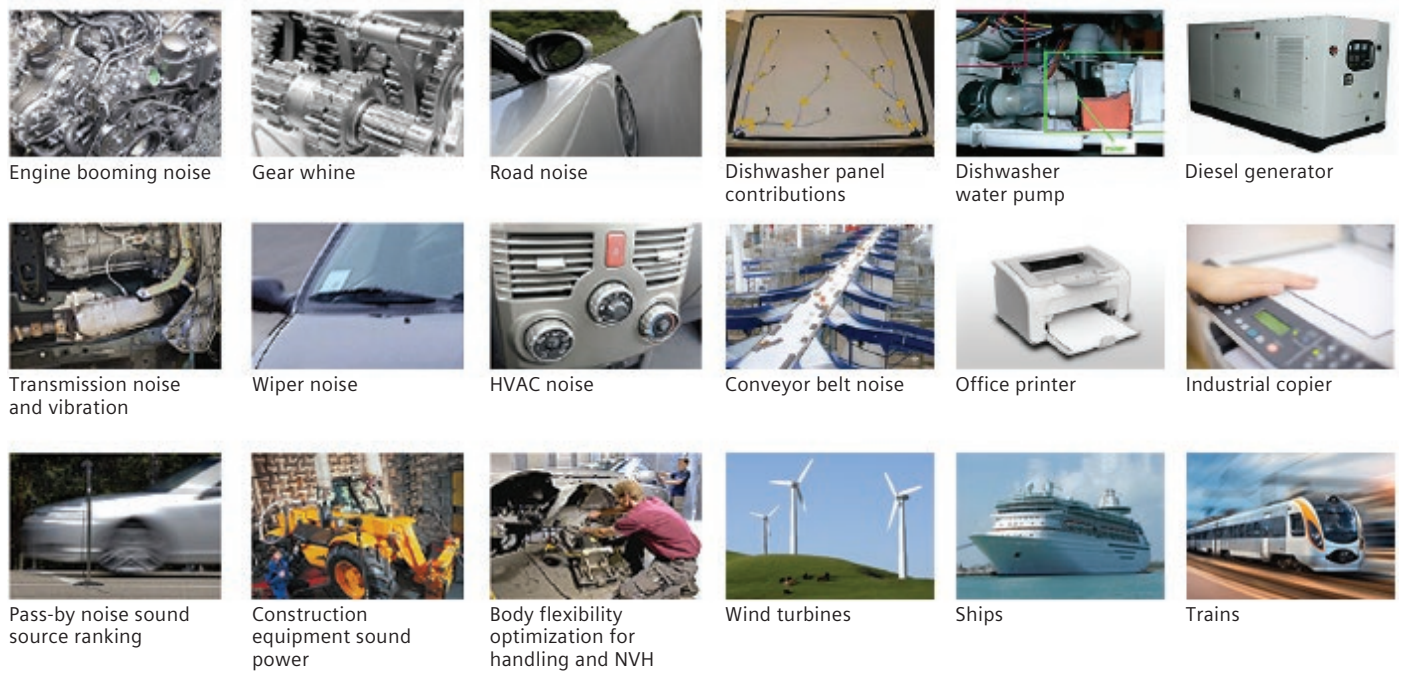

Figure 7: Industry examples of transfer path analysis.



# The TPA process

The test procedure to build a conventional TPA model typically requires two basic steps:

1. Identifying the operational loads during in-operation tests on the road or on a chassis dyno, such as runup and rundown.
2. Estimating the FRF from excitation tests, typically in laboratory conditions, such as hammer impact tests and shaker tests.

The procedure is similar for both the structural and acoustical loading cases, but the practical implementation is governed by the nature of the signals and the loads. Step one and two can be performed in reverse order. Nonetheless, it is preferred to follow this sequence, as in most cases the source needs to be removed before executing step 2. It is rather difficult to reinstall the source afterwards in the exact same way.

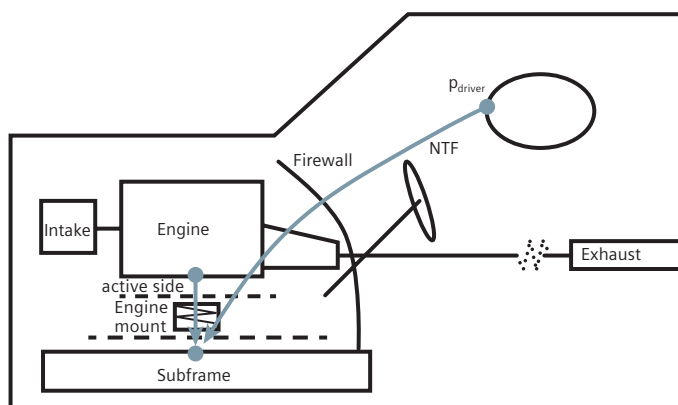

Figure 8: Structure-borne TPA model of sources, receivers, loads and transfer functions on a vehicle model.

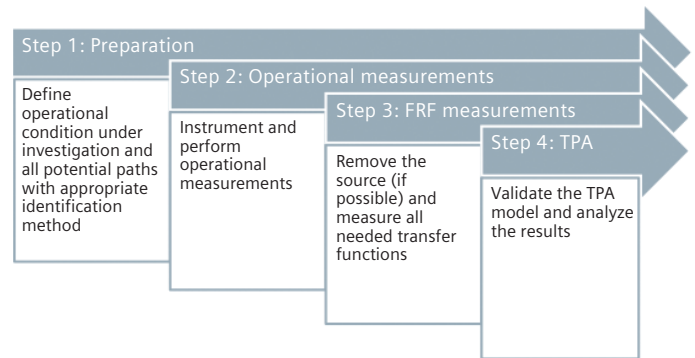

Figure 9: Test-based transfer path analysis process.

TPA has evolved to the point where it is integrated into the simulation process, resulting in the introduction of contribution-analysis concepts in numerical modeling. This has extended the traditional unit-force finite element (FE) validation models to true engineering models with realistic loads that can be used to interpret results for critical problem areas, such as panels, structural parts, etc. Experimental TPA has become a key part of simulating modeling by providing accurate load estimates.

## Structure-borne loads estimation

Estimating load levels is the main factor in achieving an accurate TPA campaign. There are four methods to estimate structure-borne interface forces: direct force, mount stiffness, matrix inversion and OPAX.

## Direct measurements

Directly measuring loads is done by placing force transducers between the source and receiver. Although it is the most basic method, in most cases it is not possible to directly measure loads as the load cells require space and well-defined support surfaces, which often makes it impractical or impossible to apply without distorting the natural mounting situation. Logically, this is the preferred method when possible; for example, for large machinery.

**Mount stiffness method**

When the active and passive structures are connected through soft resilient mounts, the mount stiffness method can be used. The operational forces can be determined by the known dynamic stiffness of the mounts  $K(\omega)$  and of the differential displacement over the mount during operation. In our example, the operational force can be derived by:

$$F_i(\omega) = K_i(\omega) * \frac{(a_{ai}(\omega) - a_{pi}(\omega))}{-\omega^2}$$

with  $F_i(\omega)$  the mount force,  $K_i(\omega)$  the mount stiffness profile and  $a_{ai}(\omega)$  and  $a_{pi}(\omega)$  the active and passive side mount accelerations.

As can be seen in the formula, the displacements are usually derived from acceleration measurements, and instrumented on the active and passive side of the mount. It is important to place the accelerometers as close as possible to the mount connection points – even though this is not always easy. If measured further away, the acceleration signals will not be representative of the problem at higher frequencies. For example, starting at a certain frequency, typically 500 Hz to 1 kilohertz (kHz) for an automotive mount, the local dynamics of the brackets and mount start to play an important role, which makes it difficult to accurately measure the active/passive side vibration.

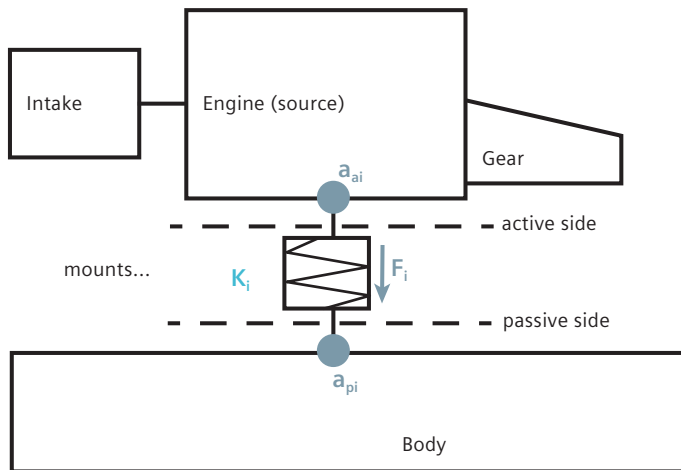

Figure 10: Estimating contact force by using the mount stiffness method.

Although this method is easy to apply, it has its limitations as accurate mount stiffness data is not always available, and depends on the excitation amplitude. This occurs due to their nonlinear behavior; the stiffness characteristics of modern mounts change depending on

the operational load level, force direction and load history of the mount.

**Matrix inversion method (inverse force identification)**

The third approach is the inverse force identification method, which identifies the operational loads  $F_i(\omega)$  ( $i = 1, \dots, n$ ) from nearby acceleration indicator responses  $a_j(\omega)$  ( $j = 1, \dots, v$ ) at the passive system side. The measured accelerations are a result of the loads acting on the system. Once the transfer functions (FRF) between the loads and the individual measured accelerations (named indicators) are known, the actual loads can be deduced by multiplying the measured accelerations with the pseudo-inverse of the force-acceleration FRF matrix. Mathematically, this can be expressed as follows:

$$[A]_{v \times 1} = [FRF]_{v \times n} [F]_{n \times 1} \Rightarrow [F]_{n \times 1} = [FRF]_{v \times n}^{-1} [A]_{v \times 1}$$

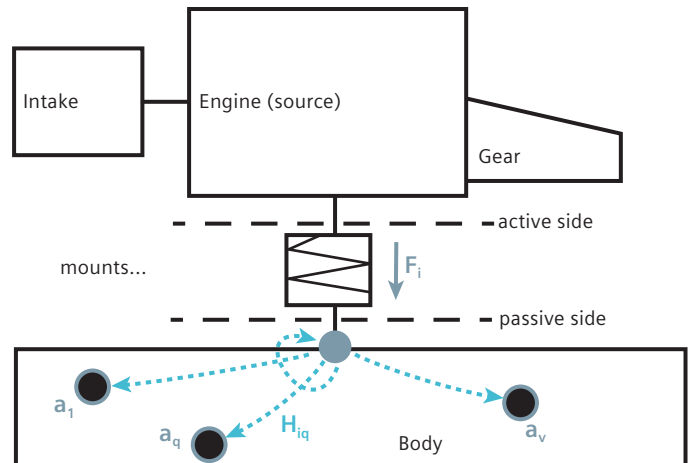

Figure 11: Estimating contact force by using the matrix inversion method.

To replace the source by a set of contact forces, the accelerant FRF matrix must be measured when the source is disconnected from the receiver. Next, this matrix is combined with operational measurements of the structural vibration at the receiver side in order to obtain force estimates.

The matrix inversion and force identification are done frequency by frequency.

This rather simple approach gets more complicated due to the numerical problems inherent to matrix inversion. To improve the stability of this inverse, the number of indicator responses ( $v$ ) must significantly exceed the

number of forces (n). A factor of 2 is a good rule of thumb to minimize conditioning problems when calculating the pseudo-inverse.

### OPAX

By adding a parametric model based on the type of physical path under investigation, the OPAX method allows you to reduce the number of indicator measurements needed for each path, and, therefore, significantly reduces the measurement effort compared to the matrix inversion method. The unknowns that will be estimated are the parameters of the model chosen specifically for each path. Once the model parameters are known, the forces/contributions can be calculated in a straightforward manner (Gajdatsy, 2011)<sup>1</sup>.

The OPAX method is faster than the classical matrix inversion method and does not require mount stiffness data. It balances speed of execution and path accuracy. The more extra indicators are used, the more robust the estimations and the better the path accuracy, but also more time and effort are required. Next to the operational measurements of path inputs and target(s), the method can be performed with one reciprocal FRF measurement per target point. Adding extra indicators for improving robustness and accuracy requires additional FRF measurements.

Further, estimating the parametric load models is numerically stable, certainly for paths in which soft mounts are used. The estimated model parameters may deliver additional valuable information. For example, mount stiffness characteristics can be estimated from measurement data.

Also, when applied to mechanical structures, the results are equally fast and accurate. OPAX yields the best results when noise and vibration sources are in low-/mid-frequency range. Due to its nature, the result accuracy is also optimal when the structure being tested is built with soft connections.

### Airborne loads estimation

To determine the airborne loads, a load-estimation method is required to replace the source by a number of monopoles with a certain source strength (volume velocity). To estimate the airborne loads, there are multiple methods: matrix inversion, OPAX, panel contribution analysis and sound intensity.

### Matrix inversion and OPAX

Similar to the structure-borne source, the matrix inversion and OPAX method can be used to indirectly estimate the volume velocity of a radiating surface. A number of indicator pressure responses are measured close to the radiating surface in operating conditions. Near-field transfer functions, between pressures at these indicator positions and volume velocities at the radiating surface, are processed together to calculate the operating volume velocity of the radiating patched surface.

$$[P]_{v \times 1} = [FRF]_{v \times n} [Q]_{n \times 1} \Rightarrow [Q]_{n \times 1} = [FRF]_{v \times n}^{-1} [P]_{v \times 1}$$

### Panel-contribution analysis

This point-to-point surface sampling technique enables the equivalent source volume velocity to be derived from systematic acceleration measurements on the radiating surfaces. The assumption is the acceleration, measured at a given point in the normal direction on the surface S, represents the (constant) acceleration profile that can be used in a given surface area for quantifying the volume acceleration of that surface. This requires the global radiating surface to be divided into individual surfaces from which the vibration is measured, for example, with accelerometers. The volume acceleration of each of these sampled surfaces S<sub>j</sub> is calculated as:

$$\dot{Q}_j = S_j \cdot \ddot{x}_{jn}$$

The volume velocity then can be calculated as the integral of the volume acceleration. It is important to consider the accelerations x should be the surface normal accelerations.

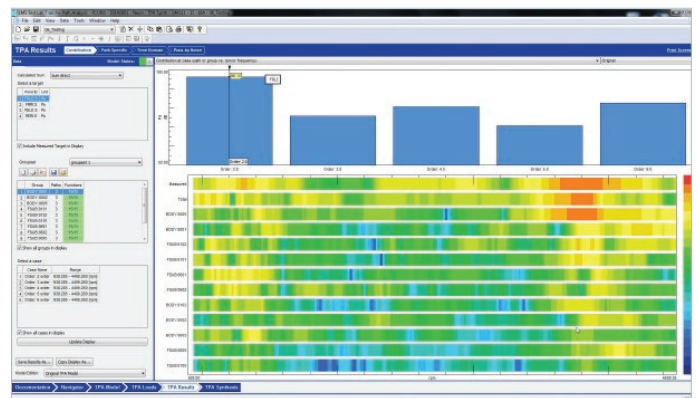

Figure 12: Panel-contribution analysis.

For measurement purposes, the continuous radiating source has to be subdivided into discrete patches. The dimension of the patches should be smaller than the smallest acoustic wavelength of interest divided by 2. Thus, the size of the patches depends on the frequency range. This technique is often called panel-contribution analysis as it is mostly used to identify the contributions from vibrating panels in a car cavity.

For higher frequencies with shorter structural wavelengths, small patches can be impractical. In this case, averaging and/or energy-based methods can provide a solution.

### Sound intensity

Similar to the panel-contribution analysis method this method is also based on the partitioning of the total panel into smaller patches. The loads are quantified, instead of measured vibrations, from the measured sound intensity on each of the local patches according to the formula below. When using this method, no phase information is available, which can be a limitation, certainly for low frequencies.

$$Q_i^2 = P_{ow_i} \frac{4\pi c}{\rho\omega^2 C} = A_i I_i \frac{4\pi c}{\rho\omega^2 C}$$

### Gathering high-quality FRF data

#### Direct measurements

Direct measurement of vibro-acoustic or (vibro-vibro) FRF is often done by instrumented hammer excitation of the structure, using a normal microphone to measure the pressure response. When more accurate data is needed, an electromechanical shaker is used for excitation. But access to the correct location is often impossible with normal shakers, and even difficult with an instrumented hammer. For these applications, the compact LMS Qsources shakers can be very helpful.

Using a vehicle as an example, surrounding parts are sometimes disassembled so they can reach locations like strut towers, ventilation system supports, screen wiper supports, etc. Alternatively, dedicated miniature integral shakers can be used (see the section on dedicated excitation methods).

Quantifying the vibro-acoustic and acoustic-acoustic FRF is usually the easiest step in the TPA process. Still, direct measurements are often complex with respect to setup constraints (apply a force at the connection points or apply an acoustic load near the radiating

surface) and accuracy (direction errors when using impact testing, connection lateral or moment constraints when using shakers).

#### Reciprocal measurements

Using reciprocal measurements, or exciting at the target locations and measuring the response at the interface, has alleviated considerable measurement problems. Verification experiments show that acoustic-acoustic and acoustic-structural reciprocity hold in nearly all cases for large ranges of excitation amplitudes and types of structures. Even in case nonlinear and/or local damping effects may cause a slight breakdown of reciprocity, the corresponding errors are typically an order smaller than those of the impact location and orientation, sensor cross-talk and sensor sensitivity.

The reciprocal determination of vibro-acoustic FRF is applicable when multiple FRFs need to be determined, and when access to the path input location is constrained. A low- or mid-frequency volume acceleration source is positioned at ear location, and the acceleration or pressure response at the path input locations is measured simultaneously for multiple input points and multiple directions per location.

Space constraints make it difficult to apply an excitation near the source especially in full-vehicle configurations; for example, the engine. With reciprocal transfer function tests, the excitation is applied at the target location, measuring the response at the source instead of the other way around. Obviously, this is a major advantage as acoustic excitation at the ear location and response accelerometers around the mounts allow more freedom in positioning the sensors close to the mount center.

#### Dedicated excitation methods

Advances in instrumentation technology for excitation and measurement have made an important contribution to industrializing TPA measurements while supporting improved accuracy.

For example, reciprocal tests require accurate acoustic sources. These sources behave like point sources, have omnidirectional characteristics in the applicable frequency ranges, and do not considerably disturb the sound field. For these tests, engineers need calibrated volume velocity sources (VVS), such as LMS Qsources, with dimensions and characteristics adapted to specific frequency ranges. These sources provide an accurate real-time reference signal of the acoustic source strength.

Reciprocal measurements of system transfer functions require the positioning of the sound source in passenger ear locations. This does not pose big challenges with regards to the size of the sound source. For other applications, such as the measurement of near-field acoustic transfer functions in confined space (to be used in matrix inversion), a small-sized, low-frequency source is needed, such as the LMS Qsources miniature VVS.

For structural excitation, traditional shakers often prove to be too bulky to apply in difficult-to-reach locations. For this reason, a range of small shakers with integrated load and acceleration sensors have been developed for LMS Qsources, which can be installed in such locations. They are self-supporting and can be used in any direction. They range from the compact integral shaker that is powerful enough to excite a complete car body, mini-shakers that can be installed inside cylinder bores or bearings and extremely small shakers that can be used to excite small structures such as computer hard drives.

These shakers are all designed to minimize dynamic loading on the system.



Figure 13: (From left to right): LMS Qsources mid- and high-frequency volume velocity source, integral shaker and low-frequency volume velocity source.

### Decoupling the system

When doing the FRF measurements, the source(s) should be removed from the system. This can be proven mathematically, but there is also a physical explanation.

Because of the system's dynamic behavior, a single force in one of the mounts causes vibrations in all path references. Excitation at a transfer path point would also cause energy to travel through the engine mount. The energy travels from the engine through a second engine mount, and from there to the receiver location

(for example, the driver's ear). The response at the receiver is thus no longer directly caused by energy traveling directly from the excitation point to the receiver. Therefore, noise transfer functions (NTFs) should be measured after disassembling the sources from the assembly structure to eliminate source coupling or cross-coupling. This means in a vehicle the engine and/or suspension need to be removed.

In some cases, the effect of cross-coupling is not that important; for example, when the mounts are soft and the excitation at the transfer path points are low due to reciprocal measurements.

### Multi-reference TPA

Transfer path analysis techniques are not only applicable for single coherent sources, such as engine noise, but also for multiple, partially correlated sources, such as road-induced noise in a car.

The wheel inputs are always partially correlated, with the degree of correlation depending on road-surface characteristics. Therefore, multi-reference cross-power measurements are necessary to properly describe a road noise problem. The number of references must be greater than the number of active sources being quantified. Classical TPA techniques can only be used for a contribution analysis of the interior noise problem if the multisource character of road-induced operational problems can be adequately described. However, the multi-reference cross-power measurements cannot be used directly in a TPA because decomposition techniques need to be used first. Road-induced noise is just one example of a vibro-acoustic issue with a multi-reference character. Other problems, such as the combined effect of air conditioning compressors and engine noise, can also be tackled by a multi-reference approach. Essentially, the process includes decomposing the multi-reference problem into a number of independent single reference cases – each describing one part of the global problem. This single reference data can be used as input data to the TPA. Path contributions can thus be determined for each of the principal components since phasing between the transfer paths still exists. In order to assess the global effect of one path, root mean square (RMS) summation is used to combine the contributions of each of the principal independent components.

## Organizing the results

A workflow-oriented tool with powerful data management capabilities helps engineers continuously check data and minimize translation issues and operator errors. Users need to perform data processing and quickly and efficiently interpret results.

The enormous amount of TPA results should be easily accessible and clearly organized. Dedicated color displays show the amplitude of the partial contributions for all selected paths as a function of RPM or frequency. Engineers are therefore able to quickly visualize the relative importance of the different paths. Figure 14 gives an example of the 4D view of TPA data. This includes:

1. Contributions per path and per case (for instance, an order) for a specific operational condition (frequency or RPM). One can easily identify which path contributes most at a certain RPM/frequency by looking at these colored contributions.
2. Contributions over the entire frequency or RPM range per path for a specific case.
3. Contributions over the entire frequency or RPM range per case for a specific path.
4. Vector displays showing the amplitudes and phase of each path for a specific case at a specific frequency or RPM. This display may indicate that working on the highest amplitude in some cases aggravates the issue under investigation due to interference.

Display 1, 2 and 3 show the paths that contribute the most in the model. Display 4 reveals which paths have canceling effects due to opposite phases and what would be the effect of the modification of a contributing path.

In a next step, we investigate why a certain dominant path is contributing so much, and the path contribution is split between source and receiver. Furthermore, other parameters for this path are analyzed; active versus passive side vibration level (in case of soft mount), local dynamic stiffness of the path connection point to the receiver, etc.

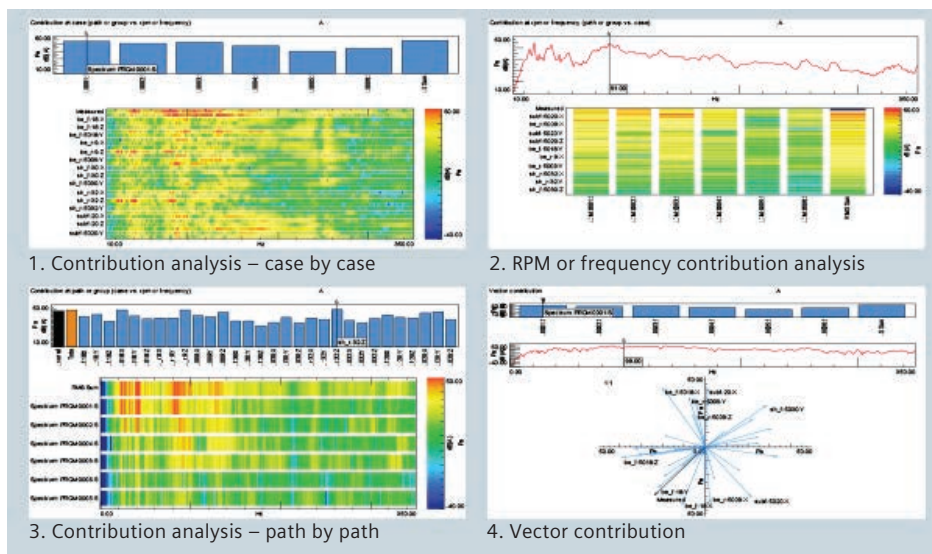
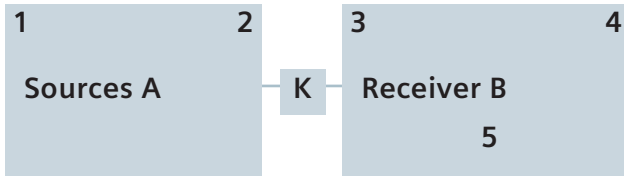

Figure 14: Contribution display (also called 4D display) with a clear overview of path contributions.

# Beyond traditional applications



Type	Method	Operational measurement		Source characterization		For contr. apply to
		Quantity	On system	Quantity	Using	Transfer functions
Classical	Direct force	$F_{3r}$	AB	Interface forces $F_{3r}$	–	$H_{34}^B$
	Mount stiffness	$A_2, A_3$	AB	Interface forces $F_{3r}$	$K$	$H_{34}^B$
	Matrix inversion	$(A_3) A_5$	AB	Interface forces $F_{3r}$	$H_{35}^B$	$H_{34}^B$
	OPAX	$(A_3) A_5$	AB	Interface forces $F_{3r}$	$H_{35}^B, Model$	$H_{34}^B$
Component based	Blocked force	$F_{2Bl}$	A (blocked)	Blocked forces $F_{2Bl}$	–	$H_{24}^{AB}$
	Free velocity	$A_2$	A (free)	Blocked forces $F_{2Bl}$	$H_{22}^A$	$H_{24}^{AB}$
Invariant source	In-situ matrix inversion	$(A_2) A_5$	AB/AR	Blocked forces $F_{2Bl}$	$H_{22(25)}^{AB/AR}$	$H_{24}^{AB}$
(Transmissibility based)	O(T)PA	$A_2, A_4$	AB	–	–	$T_{24}^B$

Figure 15: Overview of structure-borne TPA methods and their characteristics.

Today the main drivers for innovations in TPA is the industry’s demand for simpler and faster methods, and engineers trying to extend the accuracy of the method’s application range. To cope with certain application cases the general TPA process had to be modified and specific methodologies were developed. A short list of structure-borne TPA methods can be found in figure 15. An extensive overview of all TPA methods explained from the same substructuring framework can be found in a dedicated technical paper (Van der Seijs, de Klerk, & Rixen, 2016)<sup>2</sup>.

### Speeding up the TPA process

Several attempts have been made to speed up the TPA process. One example is the operational path analysis (OPA or OPA) approach. This approach requires only operational data measured at the path references (for example, passive-side mount accelerations, pressures close by vibrating surfaces, nozzles and apertures, etc.) and target points. The OPA method is time efficient, but has several limitations that make the reliability and

accuracy unpredictable: difficult transmissibility estimation, neglected cross-coupling between paths, effect of missing paths and OPA sum as a quality indicator (Bianciardi, Janssens, & Britte, 2013)<sup>3</sup>. The user risks applying incorrect counter measures.

As described in the section on OPAX, Simcenter Testlab OPAX software is an alternative, fast and test-based procedure that supports troubleshooting of vibro-acoustic problems in an efficient manner (Gajdatsy, 2011). The Simcenter Testlab OPAX solution separates loads and transfer paths. By doing so, the vibro-acoustic energy can be traced back to the source (Geluk, et al., 2011)<sup>4</sup>. This method has proven its reliability and efficiency, especially for soft-mount applications (for example, powertrain structure-borne paths).

### Energetic power-based ASQ

Recently, a power-based acoustic source quantification (ASQ) approach was developed to overcome the limitations of the phase-based approach at high frequencies (Janssens, Bianciardi, Britte, Van de Pongeele, & Van der

Auweraer, 2014)<sup>5</sup>. When extending the frequency range to several kHz, the discretization into point sources becomes dense due to the short wavelengths. Moreover, estimating the operational loads by matrix inversion becomes sensitive to phase errors. A power-based approach is more suited in that case.

The power-based ASQ model assumes uncorrelated loads and omits the phase information in the formulation. With such an approach, larger surface areas or patches can be created that are represented by an average source strength. The target responses can then be formulated as follows:

$$y_k^2(\omega) = \sum_{j=1}^n NTF_{ki}^2(\omega) \cdot Q_i^2(\omega)$$

With  $Q_i$  the acoustic loads expressed as autopower spectra. The noise transfer functions in this equation should be considered as an average transfer from several discrete point sources. Here again, the acoustic loads are identified using a pressure inversion method. This can be expressed as:

$$Q_i^2(\omega) = [H_{ji}^2(\omega)]^{-1} \cdot \{y_j^2(\omega)\}$$

Still, one of the remaining drawbacks of the energetic pressure inversion is that it can return negative load-power estimations, which is not physically realistic. There can be several reasons for this, such as measurement noise on the data, missing sources in the analysis, etc. However, this drawback can be overcome by solving the above system of equations with a constrained

least squares method, forcing the load estimates to be positive.

An example of the application is the field of pass-by noise (PBN) engineering, where it is needed to assess the contributions of all acoustic sources to the PBN microphones during a specific condition. You want to be able to assess the relative importance of the engine, tire, exhaust, etc., to the PBN microphones. Recent changes to PBN legislation put pressure on all automotive OEMs, tire and exhaust suppliers to achieve these new maximum sound levels. Since the frequency range is beyond the typical limits of the regular TPA process, the power-based TPA methodology can be applied. These measurements can be performed outside on a test rig (exterior PBN), or inside on a standard compliant chassis dynamometer (see figure 16).

### Time-domain TPA

Although TPA models are best assembled and calculated in frequency domain, there are three main reasons it is beneficial to analyze a TPA model in time domain:

- When a sound quality analysis of the partial path contributions, either objective (metrics) or subjective (replay), is required
- If the operational data contains transient or impulsive phenomena and needs to be preserved when assessing the TPA model
- For measuring all indicators at once in a multi-reference TPA case to avoid the need for preprocessing the data with principal components analysis (PCA)

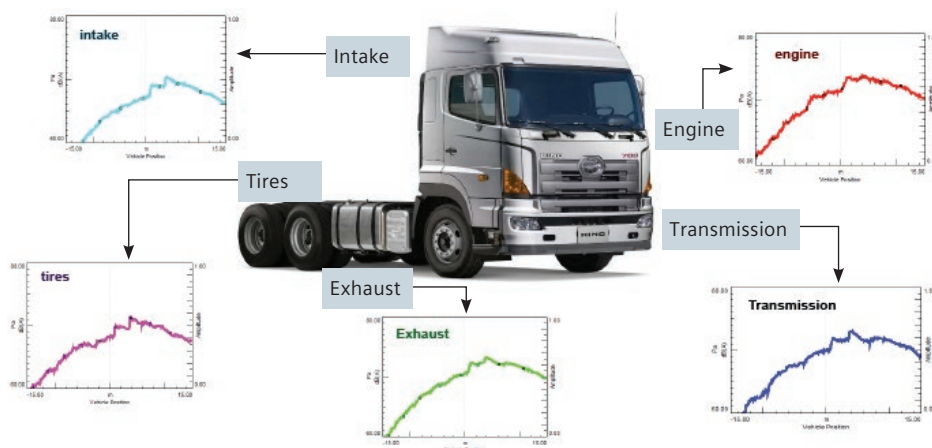

Figure 16: Energetic TPA applied to a truck to identify main contributions to PBN using energy-based ASQ techniques.



In general, the TPA approach is applied to stationary, pseudo-stationary and runup problems such as engine and road noise. Obviously, there is a lot of interest in applying this methodology to transient NVH problems, such as road bumps, high-frequency suspension noise, engine start-stop, and all kinds of phenomena in secondary noise sources in the vehicle. However, the TPA results mentioned so far are all described in the frequency domain. Transient and impulsive phenomena are therefore changed and even lost when observing path contributions in the frequency domain. Time-domain TPA has some advantages over the frequency-domain TPA process, but one of the drawbacks is all operational indicator sensors have to be measured at the same time while in the f-domain. This can be done in batches.

Time-domain TPA is a method in which the transfer path NTFs are presented as filters in the time domain. The multiplication of a force with a transfer function in the frequency domain in the time domain becomes a convolution of an NTF filter with the time series of a load, resulting in the contribution of that path to the receiver in the time domain. Additionally, that path can be listened to in the same operational condition as in the original measurement, and/or further processed with sound quality tools.

Clearly, the crucial part of creating TPA models is identifying loads. For time-domain TPA, all described methods (direct, mount stiffness, matrix inversion, OPAX) can be used for identifying loads. In the frequency domain, the load identification is the multiplication of a set of indicators with a frequency source model. By using a finite impulse response (FIR) filter of this frequency source model, the multiplication translates into a convolution in time domain of this FIR filter with the time series of the indicators. Next, the loads are identified in the time domain and can be further convoluted with a FIR filter of a transfer path NTF. The whole frequency-domain TPA model can thus also be modeled in time domain, as described in figure 17.

The time-domain approach offers interesting perspectives on how to treat problems involving nonlinear components such as mounts. Time-domain TPA based on hybrid models using multibody dynamics models for the loads offer a great potential for transient engine and suspension problems.

Also, when interested in auralization and the effect of each contribution to the perceived sound, time-domain TPA might be the solution. With a tool such as Simcenter Testlab, the time-domain TPA results can be replayed. Users can listen to the effect of enabling/disabling specific contributions,

apply a number of filters to generate a superior target signal, activate filter sets/paths instantaneously, compare several (modified) TPA models, perform A/B comparison with several cases, calculate metrics based on resulting traces, etc.

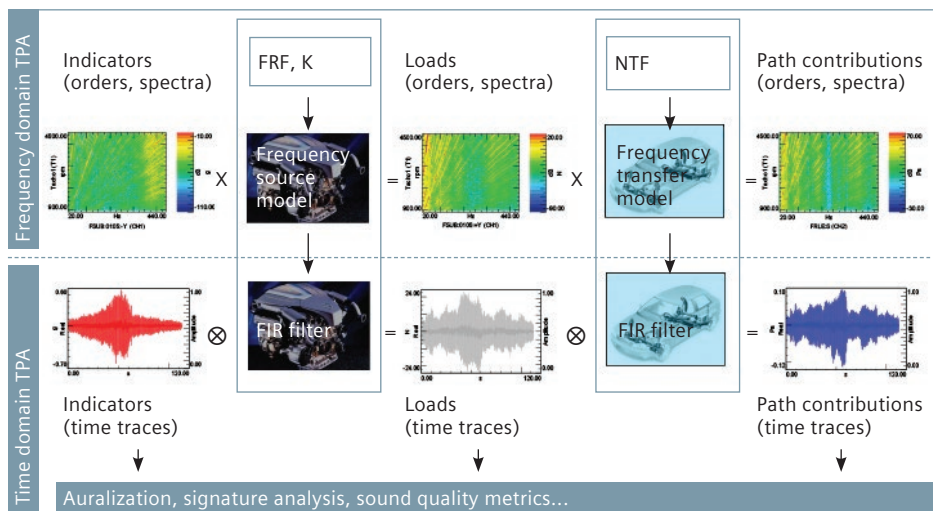

Figure 17: This figure shows a schematic overview of how time domain equivalent FIR filters are derived from frequency domain models to perform the time-domain TPA analysis.

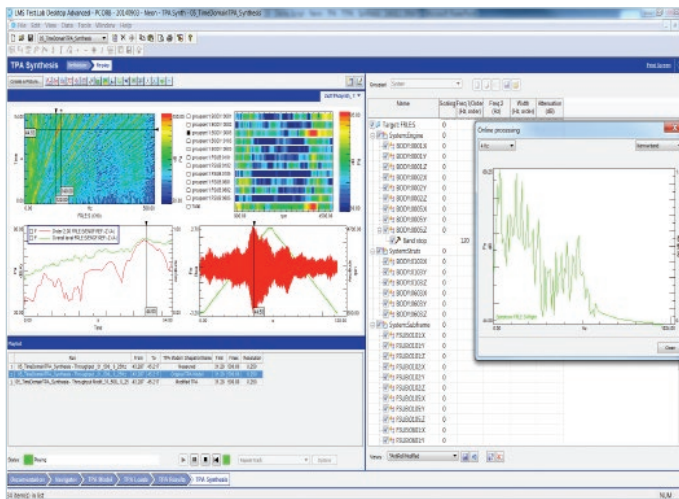

Figure 18: With Simcenter Testlab, users can listen to the effect of disabling a certain path and modify certain contributions.

### Strain-based TPA

For example, addressing the need for low-frequency TPA to investigate the ride and handling of a vehicle, strain-based TPA might be the solution. When using the matrix inversion method with accelerometers as indicators in the lower-frequency domain, there will not be enough information to separate the input loads since the responses are quite similar and dominated by a low number of modes of the structure. To address this issue, strain measurements placed close to the input locations to capture local phenomena can be used to allow a good separation of (close) paths. This methodology is applied in several cases and typically relates to ride or handling analysis. Additionally, this is also applied to the separation of closely spaced transfer paths; for example, road-noise TPA. More in-depth information on the implications of using strain instead of acceleration is available in a dedicated white paper (Geluk, et al., 2011<sup>4</sup>).

### Component-based TPA (blocked forces)

Component-based TPA is a relatively new approach that allows you to evaluate the source-component contributions upfront from dedicated test rig measurements during the vehicle development process. The objective of component-based TPA is to identify the invariant source loads from test rig data, and then combine these with noise transfer functions of the vehicle to predict the interior noise perceived by driver and passengers.

Any of the traditional TPA methods characterize source components as loads in a specific application. This means an engine that is used in different vehicles does

not necessarily create the same TPA loads in each application. To characterize the loads of a source component as independent from its built-in application, they should be characterized in a universal condition that has no variable dynamic influence. The concept of blocked forces starts from this approach and characterizes the source components by the loads that are exercised in the mounting locations when they are clamped or blocked in space. Mathematically, it can easily be proven that these blocked forces can also be derived from free-velocity measurements at the mount locations if the source is suspended in free-free conditions. Neither of the clamped or free-free conditions is easy to achieve in practice, but the blocked forces can also be derived from in-situ measurements. A significant drawback of the latter is the difficulty measuring transfer functions in assembled conditions due to the poor accessibility of many mounting points.

In the end, having a source characterization independent from its application allows that source to be evaluated in other applications without having to test each situation. The fact they can be characterized on test benches and confidently integrated in multiple cases creates new opportunities in the areas of target setting, subsystem development and OEM-supplier collaboration. The blocked forces approach allows the sources to be incorporated as components in FRF-based substructuring methods. Building libraries of components and subsystems with their associated transfer functions allow OEMs to build accurate virtual NVH models from scratch, and evaluate assembly options without having to build costly prototypes.

### Model-based transfer path analysis

Nowadays, TPA is mainly used as a troubleshooting tool on physical vehicle prototypes, enabling NVH engineers to assess critical paths and possible causes for a specific noise problem. The drawback, however, is that TPA analysis can only be done on a physical prototype and, therefore, only a limited number of development-test-change cycles can be performed at the end of the development cycle.

The current trend in the automotive industry is to front-load the analysis earlier in the development process; for example, on an engine test bed when a physical vehicle prototype is not yet available. Being able to predict the vehicle noise upfront from engine test bed measurements earlier in the development cycle is a tremendous step forward.

Traditional test-based analysis methods, such as TPA, represent a vehicle as a source-transfer-receiver system. The basic assumption behind this method is the passive side is a linear system, or, at least, it can be linearized around a working point that is valid for the analysis. When engine/transmission/driveline/wheel suspension are considered as the active side (and the trimmed body is consequently considered the passive side), this assumption is generally fulfilled. When the engine is considered the active side (and driveline/wheel suspension/trimmed body as passive), this assumption is less valid, especially for the transfer path of the torsional vibrations traveling through the driveline, wheel suspension and body.

TPA models can be used for modifying predictions by performing what-if analysis on either the loads or the transfer paths. The validity of the results depends on:

- When passive side changes are simulated by modifying the transfer function, the underlying assumption is that active side forces are invariant for these changes
- When active side changes are simulated by modifying some of the loads, the underlying assumption is the other loads are not affected by these changes

For some applications, such as low-frequency booming, these assumptions become problematic. When driveshaft stiffness is changed, this affects the driveline torsional modes so torque variations at the output of the powertrain will be altered. When suspension is changed, this affects the unsprung mass modes and the way they couple with driveline modes so torsional vibrations will be affected.

On top of this, the behavior of many elements in the powertrain is nonlinear and depends on the preload. Dynamic engine mount stiffness relies on static preload from engine

torque and is affected by throttle position, engine rotational speed and the transmission ratio (gear). Clutch stiffness, especially in the case of a dual mass flywheel (DMF), depends on static preload from powertrain torque. Suspension bushing stiffness relies on static preload from traction force.

Classical TPA methodologies are less effective for studying the effect of the transmission-driveline-suspension transfer path for torsional vibration issues. Although TPA methodologies may be able to describe the as-is state of the vehicle, it has limited modification prediction capabilities.

An alternative to classical TPA analysis is to predict the loads on the vehicle body by using simulation models. Starting from measured or simulated combustion pressures, the torque variations on the crankshaft can be modeled; for example, by how it flows through the transmission elements and the driveshaft towards the suspended wheels of the vehicle. In combination with the forces acting on the engine mounts, this allows the user to predict the vehicle loads, which are responsible for the cabin noise and vibration. Furthermore, these models do not solely allow assessment of the as-is situation; they allow for analysis of the root cause of the torsional vibration issue, and enable you to investigate the effect of design modifications. Moreover, they can be re-used in the early design phase to ensure that NVH targets are balanced with other attributes throughout the development cycle (Dos Santos, et al., 2017)<sup>6</sup>.

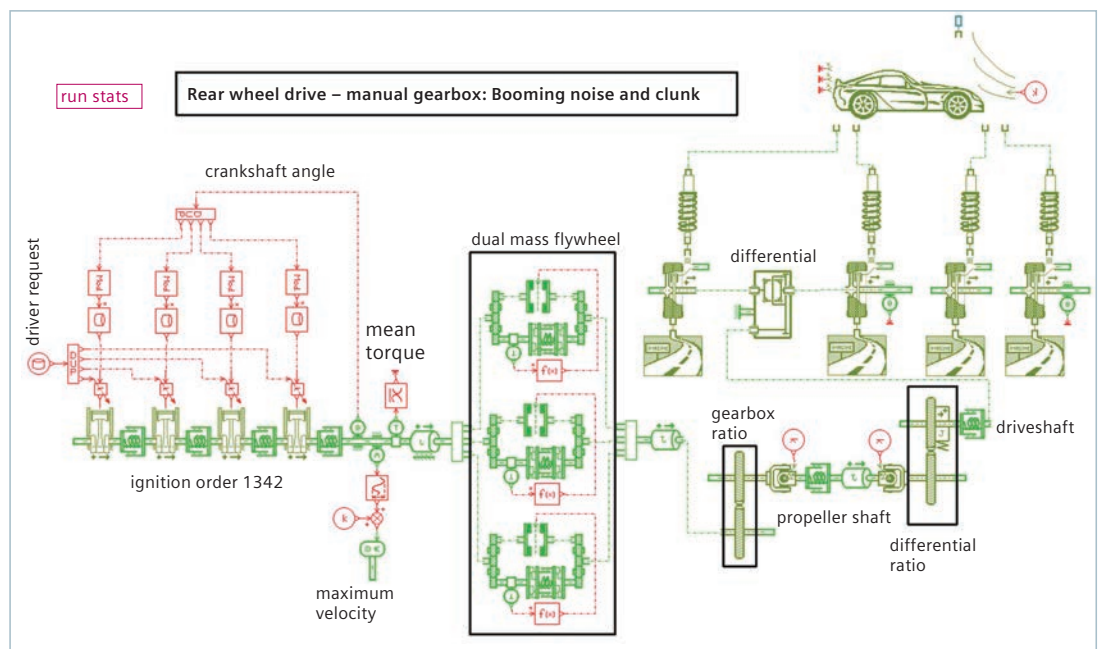

Figure 19: Full vehicle torsional 1D simulation model.

# Providing a more systematic approach to vibro-acoustic design

Transfer path analysis is a systematic approach to identify and assess structure-borne and airborne energy transfer routes from the excitation source to a given receiver location. TPA enables you to quantify the various sources and their paths, figure out which are important, which contribute to the noise issues and which ones cancel each other out.

Different TPA methods are applicable, test-based and/or simulation-based. The preferred methodology depends on the structure, single or multi-reference sources, and the stage of the development. It is applied for benchmarking and target setting, vehicle development and pass-by noise engineering. TPA provides complete insight into NVH behavior, and leads to faster troubleshooting, better product refinement and a more systematic approach to vibro-acoustic design.

## Bibliography

1. Gajdatsy, P. A. (2011). "Advanced Transfer Path Methods" KULeuven. Leuven, Belgium.
2. van der Seijs, M., de Klerk, D., Rixen, D.J. (2016) "General framework for transfer path analysis: History, theory and classification of techniques." *Mechanical Systems and Signal Processing*, 68:69, 2017:244.
3. Bianciardi, F., Janssens, K., & Britte, L. (2013). "Critical assessment of OPA: effect of coherent path inputs and SVD truncation." 20th international congress on Sound & Vibration. Bangkok, Thailand.
4. Geluk, T., Van der Linden, P., Vige, D., Caudano, M., Gottardi, S., Ciruolo, F., & Mir, H. (2011). "Noise Contribution Analysis at Suspension Interfaces Using Different Force Identification Techniques." SAE International, 2011-01-1600.
5. Janssens, K., Bianciardi, F., Britte, L., Van de Ponsele, P., Van der Auweraer, H. (2014). "Pass-by noise engineering: a review of different transfer path analysis techniques." ISMA. Leuven, Belgium.
6. Dos Santos, F., Enault, T., Deleener, J., Van Houcke, T., (2017) "Model Based Approach by Combination of Test and Simulation Methodologies for NVH Investigation and Improvement of a Rear Wheel Drive Vehicle." SAE Noise And Vibration Conference. Michigan, United States.

## Siemens PLM Software

### Headquarters

Granite Park One  
5800 Granite Parkway  
Suite 600  
Plano, TX 75024  
USA  
+1 972 987 3000

### Americas

Granite Park One  
5800 Granite Parkway  
Suite 600  
Plano, TX 75024  
USA  
+1 314 264 8499

### Europe

Stephenson House  
Sir William Siemens Square  
Frimley, Camberley  
Surrey, GU16 8QD  
+44 (0) 1276 413200

### Asia-Pacific

Unit 901-902, 9/F  
Tower B, Manulife Financial Centre  
223-231 Wai Yip Street, Kwun Tong  
Kowloon, Hong Kong  
+852 2230 3333

## About Siemens PLM Software

Siemens PLM Software, a business unit of the Siemens Digital Factory Division, is a leading global provider of software solutions to drive the digital transformation of industry, creating new opportunities for manufacturers to realize innovation. With headquarters in Plano, Texas, and over 140,000 customers worldwide, Siemens PLM Software works with companies of all sizes to transform the way ideas come to life, the way products are realized, and the way products and assets in operation are used and understood. For more information on Siemens PLM Software products and services, visit [www.siemens.com/plm](http://www.siemens.com/plm).

©2018 Siemens Product Lifecycle Management Software Inc. Siemens and the Siemens logo are registered trademarks of Siemens AG. Femap, HEEDS, NX, Simcenter 3D and Teamcenter are trademarks or registered trademarks of Siemens Product Lifecycle Management Software Inc. or its subsidiaries in the United States and in other countries. Simcenter, Simcenter Amesim, LMS Samtech Samcef, LMS Samcef Caesam, Simcenter SCADAS, Simcenter SCADAS XS, Simcenter Testxpress, Simcenter Soundbrush, Simcenter Sound Camera, Simcenter Testlab and LMS Virtual.Lab are trademarks or registered trademarks of Siemens Industry Software NV or any of its affiliates. STAR-CCM+ and STAR-CD are trademarks or registered trademarks of Siemens Industry Software Computational Dynamics Ltd. All other trademarks, registered trademarks or service marks belong to their respective holders.

71603-A9 9/18 B